

BORA

Cod. 46. - 46.RTR

Scheda tecnica



Ruota Piroettante Bora

Ruota piroettante di diametro **50 mm** in polipropilene nero o colorato e cuffietta stretta, disponibile **con freno** e con battistrada **gommato antitraccia** in PE o TPE. Capacità di carico di **35 kg**.

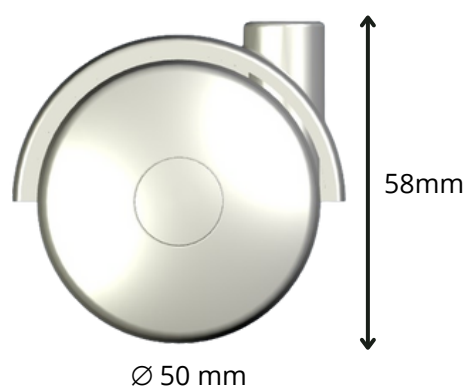

Diametro
50 mm

Portata
35 kg

Altezza Ruota
58 mm

Materiale
Polipropilene e
PE/TPE

Colori
Nero, Bianco, Grigio,
a richiesta

Varianti disponibili

- 01. Ruota con freno**
- 02. Ruota in gomma**
- 03. Variante ReLife**



Dotata di freno per bloccare il movimento della ruota, garantendo stabilità e sicurezza.







Rivestimento in PE o TPE anti-traccia, progettato per proteggere superfici delicate come il parquet e garantire spostamenti silenziosi.





Con plastiche riciclate certificate, contribuisce al recupero dei materiali e alla riduzione dell'impatto ambientale.



Accessori correlati

	<p>Perno ruota godronato</p> <ul style="list-style-type: none"> • Ø 8 x 10 - Gambo 7 x 27 • Ø 8 x 12 - Gambo 7 x 27 • Ø 8 x 13 - Gambo 7 x 27 • Ø 8 x 16 - Gambo 7 x 27 • Ø 8 x 20 - Gambo 7 x 27 • Ø 8 x 28 - Gambo 7 x 27 		<p>Perno ruota a scatto</p> <ul style="list-style-type: none"> • Ø 6 x 20,6 gola - Gambo 7 x 27 • Ø 7 x 32 - Gambo 7 x 27 • Ø 8 x 17 - Gambo 7 x 27
	<p>Perno ruota ad anello</p> <ul style="list-style-type: none"> • Ø 8 x 20 - Gambo 7 x 27 • Ø 8 x 30 - Gambo 7 x 27 • Ø 11 x 20 - Gambo 7 x 27 		<p>Perno ruota filettato</p> <ul style="list-style-type: none"> • Ø M6 x 12 - Gambo 7 x 27 • Ø M6 x 15 - Gambo 7 x 27 • Ø M8 x 15 - Gambo 7 x 27 • Ø M8 x 32 - Gambo 7 x 27 • Ø M10 x 15 - Gambo 7 x 27 • Ø M8 x 10 rondella 18 - Gambo 7 x 27 • Ø M8 x 12 rondella 18 - Gambo 7 x 27
	<p>Attacco a piastra</p> <ul style="list-style-type: none"> • 28x28 - Interasse 20 x 20 - Gambo 7 x 27 • 38x38 - Interasse 28 x 28 - Gambo 7 x 27 • 42x42 - Interasse 32 x 32 - Gambo 7 x 27 		

Riduttori

	<p>Riduttori a scatto</p> <ul style="list-style-type: none"> • Riduttore Diam. 8 mm x altezza 26 mm - compatibilità PN. 7x27 - 6x20,8 • Riduttore Diam. 9 mm x altezza 27 mm - compatibilità PN. 7x27 - 7x32 • Riduttore Diam. 10 mm x altezza 27 mm - compatibilità PN. 7x27 - 7x32 • Riduttore Diam. 10 mm x altezza 23 mm - compatibilità PN. 7x27 - 6x20,8 • Riduttore Diam. 12 mm x altezza 22 mm - compatibilità PN. 7x27 - 8x17 • Riduttore Diam. 13 mm x altezza 19 mm - compatibilità PN. 7x27 - 8x17 • Riduttore Diam. 14 mm x altezza 23 mm - compatibilità PN. 7x27 - 8x17 • Riduttore Diam. 18 mm x altezza 27 mm - compatibilità PN. 7x27 - 7x32 • Riduttore Diam. 20 mm x altezza 30 mm - compatibilità PN. 7x27 - 7x32 • Riduttore Diam. 23 mm x altezza 29 mm - compatibilità PN. 7x27 - 7x32 • Riduttore Diam. 28 mm x altezza 43 mm - compatibilità PN. 7x27 - 7x32
	<p>Riduttori rivettati</p> <ul style="list-style-type: none"> • Riduttore Diam. Tubolare 8 mm x altezza 27 mm / cod. 2-0155 • Riduttore Diam. Tubolare 8 mm x altezza 22 mm / cod. 2-0157 • Riduttore Diam. Tubolare 10 mm x altezza 25 mm / cod. 2-0136 • Riduttore Diam. Tubolare 12 mm x altezza 25 mm / cod. 2-0140 • Riduttore Diam. Tubolare 12 mm x altezza 28 mm / cod. 2-0142 • Riduttore Diam. Tubolare 13 mm x altezza 28 mm / cod. 2-0141 • Riduttore Diam. Tubolare 15 mm x altezza 29 mm / cod. 2-0144 • Riduttore Diam. Tubolare 16 mm x altezza 29 mm / cod. 2-0145 • Riduttore Diam. Tubolare 18 mm x altezza 28 mm / cod. 2-0146 • Riduttore Diam. Tubolare 20 mm x altezza 28 mm / cod. 2-0148 • Riduttore Diam. Tubolare 23 mm x altezza 28 mm / cod. 2-0150



BORA

Cod. 46. - 46.RTR

Technical data sheet



Bora Swivel Castor

50 mm diameter swivel castor made of black or coloured polypropylene and narrow cap, available **with brake** and with **non-marking rubber tread** made of PE or TPE. Load capacity of **35 kg**.

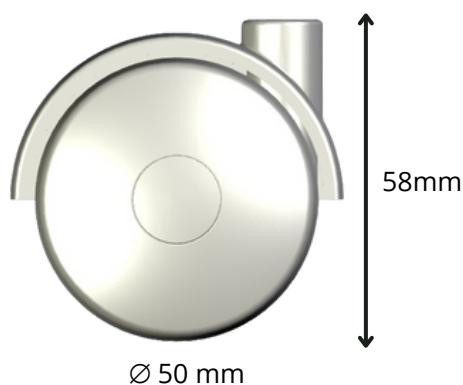

Diameter
50 mm

Load Capacity
35 kg

Height
58 mm

Material
Polypropylene and
PE/TPE

Colours
Black, White, Grey,
upon request

Product Versions

01.

Brake Castor



Provided with a brake to stop wheel movement, ensuring stability and safety.

02.

Rubber Castor



Non-marking PE or TPE coating, designed to protect delicate surfaces such as parquet and ensure silent movement.

03.





ReLife Line





With certified recycled plastics, it contributes to the recovery of materials and the reduction of environmental impact.



Accessories

	<p>Knurled Pin</p> <ul style="list-style-type: none"> • Ø 8 x 10 - Stem 7 x 27 • Ø 8 x 12 - Stem 7 x 27 • Ø 8 x 13 - Stem 7 x 27 • Ø 8 x 16 - Stem 7 x 27 • Ø 8 x 20 - Stem 7 x 27 • Ø 8 x 28 - Stem 7 x 27 		<p>Grip Neck Pin</p> <ul style="list-style-type: none"> • Ø 6 x 20,6 gola - Stem 7 x 27 • Ø 7 x 32 - Stem 7 x 27 • Ø 8 x 17 - Stem 7 x 27
	<p>Circlip Pin</p> <ul style="list-style-type: none"> • Ø 8 x 20 - Stem 7 x 27 • Ø 8 x 30 - Stem 7 x 27 • Ø 11 x 20 - Stem 7 x 27 		<p>Threaded Pin</p> <ul style="list-style-type: none"> • Ø M6 x 12 - Stem 7 x 27 • Ø M6 x 15 - Stem 7 x 27 • Ø M8 x 15 - Stem 7 x 27 • Ø M8 x 32 - Stem 7 x 27 • Ø M10 x 15 - Stem 7 x 27 • Ø M8 x 10 washer 18 - Stem 7 x 27 • Ø M8 x 12 washer 18 - Stem 7 x 27
	<p>Plates</p> <ul style="list-style-type: none"> • 28x28 - Interaxle 20 x 20 - Stem 7 x 27 • 38x38 - Interaxle 28 x 28 - Stem 7 x 27 • 42x42 - Interaxle 32 x 32 - Stem 7 x 27 		

Tube Inserts

	<p>Grip Neck Tube Inserts</p> <ul style="list-style-type: none"> • Round Diam. 8 mm x 26 mm length - compatibility PN. 7x27 - 6x20,8 • Round Diam. 9 mm x 27 mm length - compatibility PN. 7x27 - 7x32 • Round Diam. 10 mm x 27 mm length - compatibility PN. 7x27 - 7x32 • Round Diam. 10 mm x 23 mm length - compatibility PN. 7x27 - 6x20,8 • Round Diam. 12 mm x 22 mm length - compatibility PN. 7x27 - 8x17 • Round Diam. 13 mm x 19 mm length - compatibility PN. 7x27 - 8x17 • Round Diam. 14 mm x 23 mm length - compatibility PN. 7x27 - 8x17 • Round Diam. 18 mm x 27 mm length - compatibility PN. 7x27 - 7x32 • Round Diam. 20 mm x 30 mm length - compatibility PN. 7x27 - 7x32 • Round Diam. 23 mm x 29 mm length - compatibility PN. 7x27 - 7x32 • Round Diam. 28 mm x 43 mm length - compatibility PN. 7x27 - 7x32
	<p>Rivet Tube Inserts</p> <ul style="list-style-type: none"> • Round Diam. 8 mm x 27 mm length / cod. 2-0155 • Round Diam. 8 mm x 22 mm length / cod. 2-0157 • Round Diam. 10 mm x 25 mm length / cod. 2-0136 • Round Diam. 12 mm x 25 mm length / cod. 2-0140 • Round Diam. 12 mm x 28 mm length / cod. 2-0142 • Round Diam. 13 mm x 28 mm length / cod. 2-0141 • Round Diam. 15 mm x 29 mm length / cod. 2-0144 • Round Diam. 16 mm x 29 mm length / cod. 2-0145 • Round Diam. 18 mm x 28 mm length / cod. 2-0146 • Round Diam. 20 mm x 28 mm length / cod. 2-0148 • Round Diam. 23 mm x 28 mm length / cod. 2-0150

