

# LIBECCIO

Cod. 78. - 78.RTR

Scheda  
tecnica



## Ruota Piroettante Libeccio

Ruota piroettante di diametro **50 mm** in polipropilene nero o colorato, disponibile **con freno** e battistrada dotati di **ricopertura gommata antitraccia** in PE o TPE. Capacità di carico **35 kg**.

**Diametro**  
50 mm

**Portata**  
35 kg

**Altezza Ruota**  
58 mm

**Materiale**  
Polipropilene e  
PE/TPE

**Colori**  
Nero, Bianco, Grigio,  
a richiesta

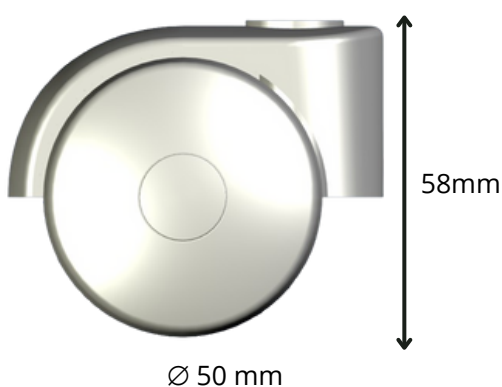

## Varianti disponibili

- 01. Ruota con freno**
- 02. Ruota in gomma**
- 03. Variante ReLife**



Dotata di freno per bloccare il movimento della ruota, garantendo stabilità e sicurezza.







Rivestimento in PE o TPE anti-traccia, progettato per proteggere superfici delicate come il parquet e garantire spostamenti silenziosi.



Con plastiche riciclate certificate, contribuisce al recupero dei materiali e alla riduzione dell'impatto ambientale.



## Accessori correlati

	<p><b>Perno ruota godronato</b></p> <ul style="list-style-type: none"> <li>• Ø 8 x 10 - Gambo 7 x 27</li> <li>• Ø 8 x 12 - Gambo 7 x 27</li> <li>• Ø 8 x 13 - Gambo 7 x 27</li> <li>• Ø 8 x 16 - Gambo 7 x 27</li> <li>• Ø 8 x 20 - Gambo 7 x 27</li> <li>• Ø 8 x 28 - Gambo 7 x 27</li> </ul>		<p><b>Perno ruota a scatto</b></p> <ul style="list-style-type: none"> <li>• Ø 6 x 20,6 gola - Gambo 7 x 27</li> <li>• Ø 7 x 32 - Gambo 7 x 27</li> <li>• Ø 8 x 17 - Gambo 7 x 27</li> <li>• Ø 8 x 34 - Gambo 8 x 27</li> <li>• Ø 10 x 28 - Gambo 8 x 27</li> <li>• Ø 10 x 37 - Gambo 8 x 27</li> </ul>
	<p><b>Perno ruota ad anello</b></p> <ul style="list-style-type: none"> <li>• Ø 8 x 20 - Gambo 7 x 27</li> <li>• Ø 8 x 30 - Gambo 7 x 27</li> <li>• Ø 11 x 20 - Gambo 7 x 27</li> </ul>		<p><b>Perno ruota filettato</b></p> <ul style="list-style-type: none"> <li>• Ø M6 x 12 - Gambo 7 x 27</li> <li>• Ø M6 x 15 - Gambo 7 x 27</li> <li>• Ø M8 x 15 - Gambo 7 x 27</li> <li>• Ø M8 x 32 - Gambo 7 x 27</li> <li>• Ø M10 x 15 - Gambo 7 x 27</li> <li>• Ø M8 x 10 rondella 18 - Gambo 7 x 27</li> <li>• Ø M8 x 12 rondella 18 - Gambo 7 x 27</li> </ul>
	<p><b>Attacco a piastra</b></p> <ul style="list-style-type: none"> <li>• 28x28 - Interasse 20 x 20 - Gambo 7 x 27</li> <li>• 38x38 - Interasse 28 x 28 - Gambo 7 x 27</li> <li>• 42x42 - Interasse 32 x 32 - Gambo 7 x 27</li> </ul>		

## Riduttori

	<p><b>Riduttori a scatto</b></p> <ul style="list-style-type: none"> <li>• Riduttore Diam. 8 mm x altezza 26 mm - compatibilità PN. 7x27 - 6x20,8</li> <li>• Riduttore Diam. 9 mm x altezza 27 mm - compatibilità PN. 7x27 - 7x32</li> <li>• Riduttore Diam. 10 mm x altezza 27 mm - compatibilità PN. 7x27 - 7x32</li> <li>• Riduttore Diam. 10 mm x altezza 23 mm - compatibilità PN. 7x27 - 6x20,8</li> <li>• Riduttore Diam. 12 mm x altezza 22 mm - compatibilità PN. 7x27 - 8x17</li> <li>• Riduttore Diam. 13 mm x altezza 19 mm - compatibilità PN. 7x27 - 8x17</li> <li>• Riduttore Diam. 14 mm x altezza 23 mm - compatibilità PN. 7x27 - 8x17</li> <li>• Riduttore Diam. 18 mm x altezza 27 mm - compatibilità PN. 7x27 - 7x32</li> <li>• Riduttore Diam. 20 mm x altezza 30 mm - compatibilità PN. 7x27 - 7x32</li> <li>• Riduttore Diam. 23 mm x altezza 29 mm - compatibilità PN. 7x27 - 7x32</li> <li>• Riduttore Diam. 26 mm x altezza 43 mm - compatibilità PN. 8x27 - 10x37</li> <li>• Riduttore Diam. 26 mm x altezza 43 mm - compatibilità PN. 8x27 - 8x34</li> <li>• Riduttore Diam. 28 mm x altezza 43 mm - compatibilità PN. 8x27 - 10x37</li> <li>• Riduttore Diam. 28 mm x altezza 43 mm - compatibilità PN. 8x27 - 10x28</li> <li>• Riduttore Diam. 28 mm x altezza 43 mm - compatibilità PN. 7x27 - 7x32</li> </ul>
--	---



# LIBECCIO

Cod. 78. - 78.RTR

## Technical data sheet



## Libeccio Swivel Castor

**50 mm** diameter swivel castor made of black or coloured polypropylene, available **with brake** and **non-marking rubber-coated tread** made of PE or TPE. Load capacity **35 kg**.

**Diameter**  
50 mm

**Load Capacity**  
35 kg

**Height**  
58 mm

**Material**  
Polypropylene and  
PE/TPE

**Colours**  
Black, White, Grey,  
upon request

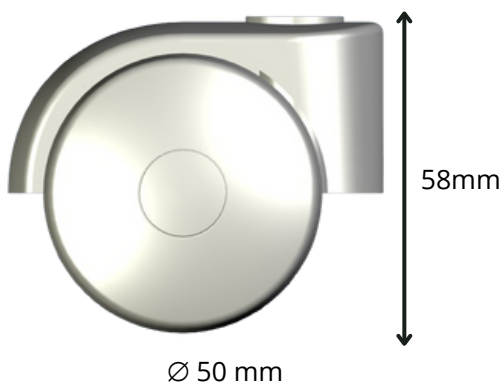

## Product Versions

01.

### Brake Castor



Provided with a brake to stop wheel movement, ensuring stability and safety.

02.

### Rubber Castor



Non-marking PE or TPE coating, designed to protect delicate surfaces such as parquet and ensure silent movement.

03.





### ReLife Line



With certified recycled plastics, it contributes to the recovery of materials and the reduction of environmental impact.



## Accessories

	<p><b>Knurled Pin</b></p> <ul style="list-style-type: none"> <li>• Ø 8 x 10 - Stem 7 x 27</li> <li>• Ø 8 x 12 - Stem 7 x 27</li> <li>• Ø 8 x 13 - Stem 7 x 27</li> <li>• Ø 8 x 16 - Stem 7 x 27</li> <li>• Ø 8 x 20 - Stem 7 x 27</li> <li>• Ø 8 x 28 - Stem 7 x 27</li> </ul>		<p><b>Grip Neck Pin</b></p> <ul style="list-style-type: none"> <li>• Ø 6 x 20,6 gola - Stem 7 x 27</li> <li>• Ø 7 x 32 - Stem 7 x 27</li> <li>• Ø 8 x 17 - Stem 7 x 27</li> <li>• Ø 8 x 34 - Stem 8 x 27</li> <li>• Ø 10 x 28 - Stem 8 x 27</li> <li>• Ø 10 x 37 - Stem 8 x 27</li> </ul>
	<p><b>Circlip Pin</b></p> <ul style="list-style-type: none"> <li>• Ø 8 x 20 - Stem 7 x 27</li> <li>• Ø 8 x 30 - Stem 7 x 27</li> <li>• Ø 11 x 20 - Stem 7 x 27</li> </ul>		<p><b>Threaded Pin</b></p> <ul style="list-style-type: none"> <li>• Ø M6 x 12 - Stem 7 x 27</li> <li>• Ø M6 x 15 - Stem 7 x 27</li> <li>• Ø M8 x 15 - Stem 7 x 27</li> <li>• Ø M8 x 32 - Stem 7 x 27</li> <li>• Ø M10 x 15 - Stem 7 x 27</li> <li>• Ø M8 x 10 washer 18 - Stem 7 x 27</li> <li>• Ø M8 x 12 washer 18 - Stem 7 x 27</li> </ul>
	<p><b>Plates</b></p> <ul style="list-style-type: none"> <li>• 28x28 - Interaxle 20 x 20 - Stem 7 x 27</li> <li>• 38x38 - Interaxle 28 x 28 - Stem 7 x 27</li> <li>• 42x42 - Interaxle 32 x 32 - Stem 7 x 27</li> </ul>		

## Tube Inserts

	<p><b>Grip Neck Tube Inserts</b></p> <ul style="list-style-type: none"> <li>• Round Diam. 8 mm x 26 mm length - compatibility PN. 7x27 - 6x20,8</li> <li>• Round Diam. 9 mm x 27 mm length - compatibility PN. 7x27 - 7x32</li> <li>• Round Diam. 10 mm x 27 mm length - compatibility PN. 7x27 - 7x32</li> <li>• Round Diam. 10 mm x 23 mm length - compatibility PN. 7x27 - 6x20,8</li> <li>• Round Diam. 12 mm x 22 mm length - compatibility PN. 7x27 - 8x17</li> <li>• Round Diam. 13 mm x 19 mm length - compatibility PN. 7x27 - 8x17</li> <li>• Round Diam. 14 mm x 23 mm length - compatibility PN. 7x27 - 8x17</li> <li>• Round Diam. 18 mm x 27 mm length - compatibility PN. 7x27 - 7x32</li> <li>• Round Diam. 20 mm x 30 mm length - compatibility PN. 7x27 - 7x32</li> <li>• Round Diam. 23 mm x 29 mm length - compatibility PN. 7x27 - 7x32</li> <li>• Round Diam. 26 mm x 43 mm length - compatibility PN. 8x27 - 10x37</li> <li>• Round Diam. 26 mm x 43 mm length - compatibility PN. 8x27 - 8x34</li> <li>• Round Diam. 28 mm x 43 mm length - compatibility PN. 8x27 - 10x37</li> <li>• Round Diam. 28 mm x 43 mm length - compatibility PN. 8x27 - 10x28</li> <li>• Round Diam. 28 mm x 43 mm length - compatibility PN. 7x27 - 7x32</li> </ul>
--	--

