

NOTO

Cod. 40. - 40.FR

*Scheda
tecnica*



Ruota Piroettante **Noto**

Ruota piroettante di diametro **45 mm** in polipropilene nero o colorato e cuffia larga, disponibile **con freno**.
Capacità di carico **25 kg**.

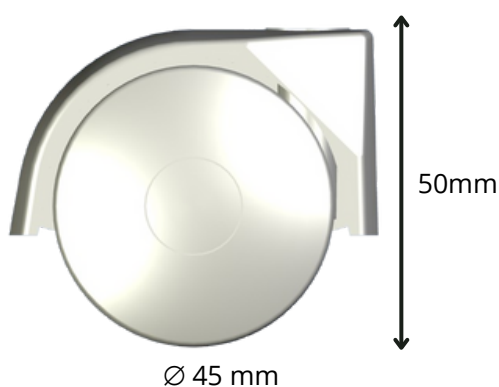

Diametro
45 mm

Portata
25 kg

Altezza Ruota
50 mm

Materiale
Polipropilene

Colori
Nero, Bianco, Grigio,
a richiesta

Varianti disponibili

01.

Ruota con freno



Dotata di freno per bloccare il movimento della ruota, garantendo stabilità e sicurezza.

02.





Variante ReLife



Con plastiche riciclate certificate, contribuisce al recupero dei materiali e alla riduzione dell'impatto ambientale.



Accessori correlati

| | | | |
|--|--|---|---|
|  | <p>Perno ruota godronato</p> <ul style="list-style-type: none"> • Ø 8 x 10 - Gambo 7 x 27 • Ø 8 x 12 - Gambo 7 x 27 • Ø 8 x 13 - Gambo 7 x 27 • Ø 8 x 16 - Gambo 7 x 27 • Ø 8 x 20 - Gambo 7 x 27 • Ø 8 x 28 - Gambo 7 x 27 |  | <p>Perno ruota a scatto</p> <ul style="list-style-type: none"> • Ø 6 x 20,6 gola - Gambo 7 x 27 • Ø 7 x 32 - Gambo 7 x 27 • Ø 8 x 17 - Gambo 7 x 27 • Ø 8 x 34 - Gambo 8 x 27 • Ø 10 x 28 - Gambo 8 x 27 • Ø 10 x 37 - Gambo 8 x 27 |
|  | <p>Perno ruota ad anello</p> <ul style="list-style-type: none"> • Ø 8 x 20 - Gambo 7 x 27 • Ø 8 x 30 - Gambo 7 x 27 • Ø 11 x 20 - Gambo 7 x 27 |  | <p>Perno ruota filettato</p> <ul style="list-style-type: none"> • Ø M6 x 12 - Gambo 7 x 27 • Ø M6 x 15 - Gambo 7 x 27 • Ø M8 x 15 - Gambo 7 x 27 • Ø M8 x 32 - Gambo 7 x 27 • Ø M10 x 15 - Gambo 7 x 27 • Ø M8 x 10 rondella 18 - Gambo 7 x 27 • Ø M8 x 12 rondella 18 - Gambo 7 x 27 |
|  | <p>Attacco a piastra</p> <ul style="list-style-type: none"> • 28x28 - Interasse 20 x 20 - Gambo 7 x 27 • 38x38 - Interasse 28 x 28 - Gambo 7 x 27 • 42x42 - Interasse 32 x 32 - Gambo 7 x 27 | | |

Riduttori

| | |
|--|---|
|  | <p>Riduttori a scatto</p> <ul style="list-style-type: none"> • Riduttore Diam. 8 mm x altezza 26 mm - compatibilità PN. 7x27 - 6x20,8 • Riduttore Diam. 9 mm x altezza 27 mm - compatibilità PN. 7x27 - 7x32 • Riduttore Diam. 10 mm x altezza 27 mm - compatibilità PN. 7x27 - 7x32 • Riduttore Diam. 10 mm x altezza 23 mm - compatibilità PN. 7x27 - 6x20,8 • Riduttore Diam. 12 mm x altezza 22 mm - compatibilità PN. 7x27 - 8x17 • Riduttore Diam. 13 mm x altezza 19 mm - compatibilità PN. 7x27 - 8x17 • Riduttore Diam. 14 mm x altezza 23 mm - compatibilità PN. 7x27 - 8x17 • Riduttore Diam. 18 mm x altezza 27 mm - compatibilità PN. 7x27 - 7x32 • Riduttore Diam. 20 mm x altezza 30 mm - compatibilità PN. 7x27 - 7x32 • Riduttore Diam. 23 mm x altezza 29 mm - compatibilità PN. 7x27 - 7x32 • Riduttore Diam. 26 mm x altezza 43 mm - compatibilità PN. 8x27 - 10x37 • Riduttore Diam. 26 mm x altezza 43 mm - compatibilità PN. 8x27 - 8x34 • Riduttore Diam. 28 mm x altezza 43 mm - compatibilità PN. 8x27 - 10x37 • Riduttore Diam. 28 mm x altezza 43 mm - compatibilità PN. 8x27 - 10x28 • Riduttore Diam. 28 mm x altezza 43 mm - compatibilità PN. 7x27 - 7x32 |
|--|---|



NOTO

Cod. 40. - 40.FR

Technical data sheet



Noto Swivel Castor

45 mm diameter swivel castor made of black or coloured polypropylene and wide cap, available **with brake**.
Load capacity **25 kg**.

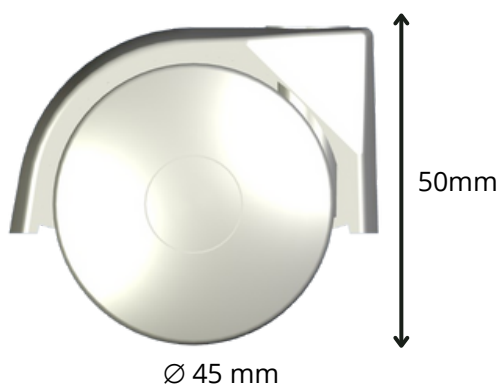

Diameter
45 mm

Load Capacity
25 kg

Height
50 mm

Material
Polypropylene

Colours
Black, White, Grey,
upon request

Product Versions

01.

Brake Castor



Provided with a brake to stop wheel movement, ensuring stability and safety.

02.





ReLife Line



With certified recycled plastics, it contributes to the recovery of materials and the reduction of environmental impact.



Accessories

| | | | |
|--|--|---|---|
|  | <p>Knurled Pin</p> <ul style="list-style-type: none"> • Ø 8 x 10 - Stem 7 x 27 • Ø 8 x 12 - Stem 7 x 27 • Ø 8 x 13 - Stem 7 x 27 • Ø 8 x 16 - Stem 7 x 27 • Ø 8 x 20 - Stem 7 x 27 • Ø 8 x 28 - Stem 7 x 27 |  | <p>Grip Neck Pin</p> <ul style="list-style-type: none"> • Ø 6 x 20,6 - Stem 7 x 27 • Ø 7 x 32 - Stem 7 x 27 • Ø 8 x 17 - Stem 7 x 27 • Ø 8 x 34 - Stem 8 x 27 • Ø 10 x 28 - Stem 8 x 27 • Ø 10 x 37 - Stem 8 x 27 |
|  | <p>Circlip Pin</p> <ul style="list-style-type: none"> • Ø 8 x 20 - Stem 7 x 27 • Ø 8 x 30 - Stem 7 x 27 • Ø 11 x 20 - Stem 7 x 27 |  | <p>Threaded Pin</p> <ul style="list-style-type: none"> • Ø M6 x 12 - Stem 7 x 27 • Ø M6 x 15 - Stem 7 x 27 • Ø M8 x 15 - Stem 7 x 27 • Ø M8 x 32 - Stem 7 x 27 • Ø M10 x 15 - Stem 7 x 27 • Ø M8 x 10 washer 18 - Stem 7 x 27 • Ø M8 x 12 washer 18 - Stem 7 x 27 |
|  | <p>Plate</p> <ul style="list-style-type: none"> • 28x28 - Interaxle 20 x 20 - Stem 7 x 27 • 38x38 - Interaxle 28 x 28 - Stem 7 x 27 • 42x42 - Interaxle 32 x 32 - Stem 7 x 27 | | |

Tube Inserts

| | |
|--|---|
|  | <p>Grip Neck Tube Inserts</p> <ul style="list-style-type: none"> • Round Diam. 8 mm x 26 mm length - compatibility PN. 7x27 - 6x20,8 • Round Diam. 9 mm x 27 mm length - compatibility PN. 7x27 - 7x32 • Round Diam. 10 mm x 27 mm length- compatibility PN. 7x27 - 7x32 • Round Diam. 10 mm x 23 mm length - compatibility PN. 7x27 - 6x20,8 • Round Diam. 12 mm x 22 mm length - compatibility PN. 7x27 - 8x17 • Round Diam. 13 mm x 19 mm length - compatibility PN. 7x27 - 8x17 • Round Diam. 14 mm x 23 mm length - compatibility PN. 7x27 - 8x17 • Round Diam. 18 mm x 27 mm length - compatibility PN. 7x27 - 7x32 • Round Diam. 20 mm x 30 mm length - compatibility PN. 7x27 - 7x32 • Round Diam. 23 mm x 29 mm length - compatibility PN. 7x27 - 7x32 • Round Diam. 26 mm x 43 mm length - compatibility PN. 8x27 - 10x37 • Round Diam. 26 mm x 43 mm length - compatibility PN. 8x27 - 8x34 • Round Diam. 28 mm x 43 mm length - compatibility PN. 8x27 - 10x37 • Round Diam. 28 mm x 43 mm length - compatibility PN. 8x27 - 10x28 • Round Diam. 28 mm x 43 mm length - compatibility PN. 7x27 - 7x32 |
|--|---|

