

TRAMONTANA

Cod. 45. - 45.RTR

Scheda tecnica



Ruota Piroettante Tramontana

Ruota piroettante di diametro **50 mm** in polipropilene nero o colorato e cuffia larga, disponibile con **ricopertura gommata** in PE o TPE per evitare danni alle superfici più delicate. Capacità di carico **50 kg**.

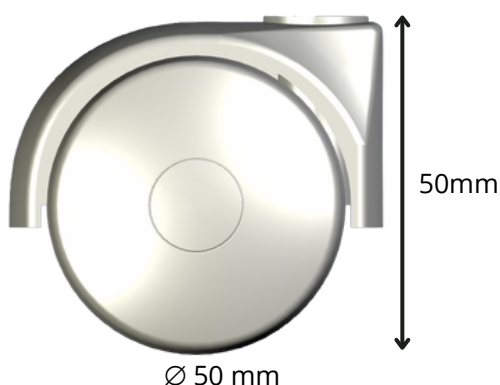

Diametro
50 mm

Portata
50 kg

Altezza Ruota
50 mm

Materiale
Polipropilene e
PE/TPE

Colori
Nero, Bianco, Grigio,
a richiesta

Varianti disponibili

01.

Ruota in gomma



Rivestimento in PE o TPE anti-traccia, progettato per proteggere superfici delicate come il parquet e garantire spostamenti silenziosi.

02.





Variante ReLife



Con plastiche riciclate certificate, contribuisce al recupero dei materiali e alla riduzione dell'impatto ambientale.



Accessori correlati

	<p>Perno ruota godronato</p> <ul style="list-style-type: none"> • Ø 8 x 10 - Gambo 7 x 27 • Ø 8 x 12 - Gambo 7 x 27 • Ø 8 x 13 - Gambo 7 x 27 • Ø 8 x 16 - Gambo 7 x 27 • Ø 8 x 20 - Gambo 7 x 27 • Ø 8 x 28 - Gambo 7 x 27 		<p>Perno ruota a scatto</p> <ul style="list-style-type: none"> • Ø 6 x 20,6 gola - Gambo 7 x 27 • Ø 7 x 32 - Gambo 7 x 27 • Ø 8 x 17 - Gambo 7 x 27 • Ø 8 x 34 - Gambo 8 x 27 • Ø 10 x 28 - Gambo 8 x 27 • Ø 10 x 37 - Gambo 8 x 27
	<p>Perno ruota ad anello</p> <ul style="list-style-type: none"> • Ø 8 x 20 - Gambo 7 x 27 • Ø 8 x 30 - Gambo 7 x 27 • Ø 11 x 20 - Gambo 7 x 27 		<p>Perno ruota filettato</p> <ul style="list-style-type: none"> • Ø M6 x 12 - Gambo 7 x 27 • Ø M6 x 15 - Gambo 7 x 27 • Ø M8 x 15 - Gambo 7 x 27 • Ø M8 x 32 - Gambo 7 x 27 • Ø M10 x 15 - Gambo 7 x 27 • Ø M8 x 10 rondella 18 - Gambo 7 x 27 • Ø M8 x 12 rondella 18 - Gambo 7 x 27
	<p>Attacco a piastra</p> <ul style="list-style-type: none"> • 28x28 - Interasse 20 x 20 - Gambo 7 x 27 • 38x38 - Interasse 28 x 28 - Gambo 7 x 27 • 42x42 - Interasse 32 x 32 - Gambo 7 x 27 		

Riduttori

	<p>Riduttori a scatto</p> <ul style="list-style-type: none"> • Riduttore Diam. 8 mm x altezza 26 mm - compatibilità PN. 7x27 - 6x20,8 • Riduttore Diam. 9 mm x altezza 27 mm - compatibilità PN. 7x27 - 7x32 • Riduttore Diam. 10 mm x altezza 27 mm - compatibilità PN. 7x27 - 7x32 • Riduttore Diam. 10 mm x altezza 23 mm - compatibilità PN. 7x27 - 6x20,8 • Riduttore Diam. 12 mm x altezza 22 mm - compatibilità PN. 7x27 - 8x17 • Riduttore Diam. 13 mm x altezza 19 mm - compatibilità PN. 7x27 - 8x17 • Riduttore Diam. 14 mm x altezza 23 mm - compatibilità PN. 7x27 - 8x17 • Riduttore Diam. 18 mm x altezza 27 mm - compatibilità PN. 7x27 - 7x32 • Riduttore Diam. 20 mm x altezza 30 mm - compatibilità PN. 7x27 - 7x32 • Riduttore Diam. 23 mm x altezza 29 mm - compatibilità PN. 7x27 - 7x32 • Riduttore Diam. 26 mm x altezza 43 mm - compatibilità PN. 8x27 - 10x37 • Riduttore Diam. 26 mm x altezza 43 mm - compatibilità PN. 8x27 - 8x34 • Riduttore Diam. 28 mm x altezza 43 mm - compatibilità PN. 8x27 - 10x37 • Riduttore Diam. 28 mm x altezza 43 mm - compatibilità PN. 8x27 - 10x28 • Riduttore Diam. 28 mm x altezza 43 mm - compatibilità PN. 7x27 - 7x32
--	---



TRAMONTANA

Cod. 45. - 45.RTR

Technical data sheet



Tramontana Swivel Castor

50 mm diameter swivel castor made of black or coloured polypropylene and wide cap, available with PE or TPE **rubberised cover** to prevent damage to delicate surfaces. Load capacity **50 kg**.

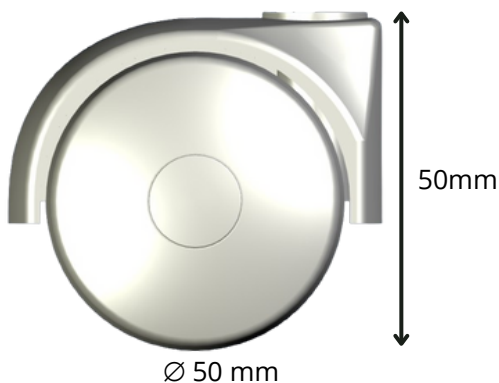

Diameter
50 mm

Load capacity
50 kg

Height
50 mm

Material
Polypropylene and
PE/TPE

Colours
Black, White, Grey,
upon request

Product Versions

01.

Rubber Castor



Non-marking PE or TPE coating, designed to protect delicate surfaces such as parquet and ensure silent movement.

02.





ReLife Line



With certified recycled plastics, it contributes to the recovery of materials and the reduction of environmental impact.



Accessories

	<p>Knurled Pin</p> <ul style="list-style-type: none"> • Ø 8 x 10 - Stem 7 x 27 • Ø 8 x 12 - Stem 7 x 27 • Ø 8 x 13 - Stem 7 x 27 • Ø 8 x 16 - Stem 7 x 27 • Ø 8 x 20 - Stem 7 x 27 • Ø 8 x 28 - Stem 7 x 27 		<p>Grip Neck Pin</p> <ul style="list-style-type: none"> • Ø 6 x 20,6 - Stem 7 x 27 • Ø 7 x 32 - Stem 7 x 27 • Ø 8 x 17 - Stem 7 x 27 • Ø 8 x 34 - Stem 8 x 27 • Ø 10 x 28 - Stem 8 x 27 • Ø 10 x 37 - Stem 8 x 27
	<p>Circlip Pin</p> <ul style="list-style-type: none"> • Ø 8 x 20 - Stem 7 x 27 • Ø 8 x 30 - Stem 7 x 27 • Ø 11 x 20 - Stem 7 x 27 		<p>Threaded Pin</p> <ul style="list-style-type: none"> • Ø M6 x 12 - Stem 7 x 27 • Ø M6 x 15 - Stem 7 x 27 • Ø M8 x 15 - Stem 7 x 27 • Ø M8 x 32 - Stem 7 x 27 • Ø M10 x 15 - Stem 7 x 27 • Ø M8 x 10 washer 18 - Stem 7 x 27 • Ø M8 x 12 washer 18 - Stem 7 x 27
	<p>Plate</p> <ul style="list-style-type: none"> • 28x28 - Interaxle 20 x 20 - Stem 7 x 27 • 38x38 - Interaxle 28 x 28 - Stem 7 x 27 • 42x42 - Interaxle 32 x 32 - Stem 7 x 27 		

Tube Inserts

	<p>Grip Neck Tube Inserts</p> <ul style="list-style-type: none"> • Round Diam. 8 mm x 26 mm length - compatibility PN. 7x27 - 6x20,8 • Round Diam. 9 mm x 27 mm length - compatibility PN. 7x27 - 7x32 • Round Diam. 10 mm x 27 mm length- compatibility PN. 7x27 - 7x32 • Round Diam. 10 mm x 23 mm length - compatibility PN. 7x27 - 6x20,8 • Round Diam. 12 mm x 22 mm length - compatibility PN. 7x27 - 8x17 • Round Diam. 13 mm x 19 mm length - compatibility PN. 7x27 - 8x17 • Round Diam. 14 mm x 23 mm length - compatibility PN. 7x27 - 8x17 • Round Diam. 18 mm x 27 mm length - compatibility PN. 7x27 - 7x32 • Round Diam. 20 mm x 30 mm length - compatibility PN. 7x27 - 7x32 • Round Diam. 23 mm x 29 mm length - compatibility PN. 7x27 - 7x32 • Round Diam. 26 mm x 43 mm length - compatibility PN. 8x27 - 10x37 • Round Diam. 26 mm x 43 mm length - compatibility PN. 8x27 - 8x34 • Round Diam. 28 mm x 43 mm length - compatibility PN. 8x27 - 10x37 • Round Diam. 28 mm x 43 mm length - compatibility PN. 8x27 - 10x28 • Round Diam. 28 mm x 43 mm length - compatibility PN. 7x27 - 7x32
--	---

