

ZEFIRO

Cod. 55. - 55.SOFT

Scheda tecnica



Ruota Piroettante Zefiro

Ruota piroettante di diametro **40 mm** in polipropilene nero o colorato e cuffietta stretta, disponibile con battistrada **gommato antitraccia** in PE o TPE. Capacità di carico di **18 kg**.

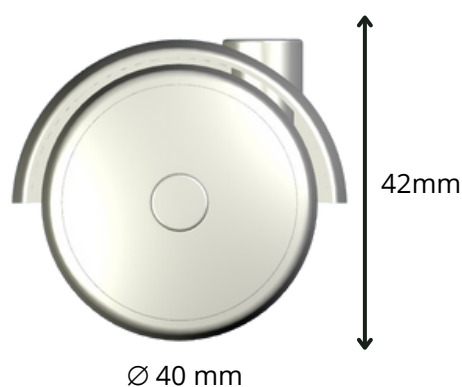

Diametro
40 mm

Portata
18 kg

Altezza Ruota
42 mm

Materiale
Polipropilene e
PE/TPE

Colori
Nero, Bianco, Grigio,
a richiesta

Varianti disponibili

01.

Ruota in gomma



Rivestimento in PE o TPE anti-traccia, progettato per proteggere superfici delicate come il parquet e garantire spostamenti silenziosi.

02.





Variante ReLife





Con plastiche riciclate certificate, contribuisce al recupero dei materiali e alla riduzione dell'impatto ambientale.



Accessori correlati

	<p>Perno ruota godronato</p> <ul style="list-style-type: none"> • Ø 8 x 10 - Gambo 7 x 27 • Ø 8 x 12 - Gambo 7 x 27 • Ø 8 x 13 - Gambo 7 x 27 • Ø 8 x 16 - Gambo 7 x 27 • Ø 8 x 20 - Gambo 7 x 27 • Ø 8 x 28 - Gambo 7 x 27 		<p>Perno ruota a scatto</p> <ul style="list-style-type: none"> • Ø 6 x 20,6 gola - Gambo 7 x 27 • Ø 7 x 32 - Gambo 7 x 27 • Ø 8 x 17 - Gambo 7 x 27
	<p>Perno ruota ad anello</p> <ul style="list-style-type: none"> • Ø 8 x 20 - Gambo 7 x 27 • Ø 8 x 30 - Gambo 7 x 27 • Ø 11 x 20 - Gambo 7 x 27 		<p>Perno ruota filettato</p> <ul style="list-style-type: none"> • Ø M6 x 12 - Gambo 7 x 27 • Ø M6 x 15 - Gambo 7 x 27 • Ø M8 x 15 - Gambo 7 x 27 • Ø M8 x 32 - Gambo 7 x 27 • Ø M10 x 15 - Gambo 7 x 27 • Ø M8 x 10 rondella 18 - Gambo 7 x 27 • Ø M8 x 12 rondella 18 - Gambo 7 x 27
	<p>Attacco a piastra</p> <ul style="list-style-type: none"> • 28x28 - Interasse 20 x 20 - Gambo 7 x 27 • 38x38 - Interasse 28 x 28 - Gambo 7 x 27 • 42x42 - Interasse 32 x 32 - Gambo 7 x 27 		

Riduttori

	<p>Riduttori a scatto</p> <ul style="list-style-type: none"> • Riduttore Diam. 8 mm x altezza 26 mm - compatibilità PN. 7x27 - 6x20,8 • Riduttore Diam. 9 mm x altezza 27 mm - compatibilità PN. 7x27 - 7x32 • Riduttore Diam. 10 mm x altezza 27 mm - compatibilità PN. 7x27 - 7x32 • Riduttore Diam. 10 mm x altezza 23 mm - compatibilità PN. 7x27 - 6x20,8 • Riduttore Diam. 12 mm x altezza 22 mm - compatibilità PN. 7x27 - 8x17 • Riduttore Diam. 13 mm x altezza 19 mm - compatibilità PN. 7x27 - 8x17 • Riduttore Diam. 14 mm x altezza 23 mm - compatibilità PN. 7x27 - 8x17 • Riduttore Diam. 18 mm x altezza 27 mm - compatibilità PN. 7x27 - 7x32 • Riduttore Diam. 20 mm x altezza 30 mm - compatibilità PN. 7x27 - 7x32 • Riduttore Diam. 23 mm x altezza 29 mm - compatibilità PN. 7x27 - 7x32 • Riduttore Diam. 28 mm x altezza 43 mm - compatibilità PN. 7x27 - 7x32
	<p>Riduttori rivettati</p> <ul style="list-style-type: none"> • Riduttore Diam. 8 mm x altezza 27 mm • Riduttore Diam. 8 mm x altezza 22 mm • Riduttore Diam. 10 mm x altezza 25 mm • Riduttore Diam. 12 mm x altezza 25 mm • Riduttore Diam. 12 mm x altezza 28 mm • Riduttore Diam. 13 mm x altezza 28 mm • Riduttore Diam. 15 mm x altezza 29 mm • Riduttore Diam. 16 mm x altezza 29 mm • Riduttore Diam. 18 mm x altezza 28 mm • Riduttore Diam. 20 mm x altezza 28 mm • Riduttore Diam. 23 mm x altezza 28 mm



ZEFIRO

Cod. 55. - 55.SOFT

Technical data sheet



Zefiro Swivel Castor

40 mm diameter swivel castor made of black or coloured polypropylene and narrow cap, available with PE or TPE **non-marking rubber tread**. Load capacity of **18 kg**.

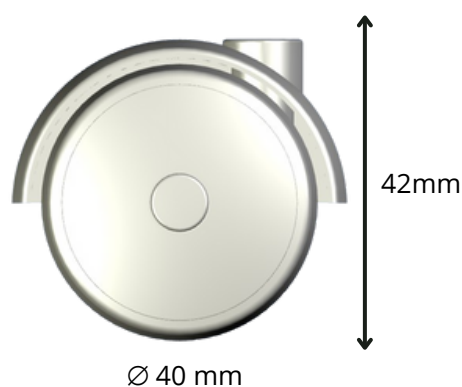

Diameter
40 mm

Load Capacity
18 kg

Height
42 mm

Material
Polypropylene and
PE/TPE

Colours
Black, White, Grey,
upon request

Product Versions

01.

Rubber Castor



Non-marking PE or TPE coating, designed to protect delicate surfaces such as parquet and ensure silent movement.

02.





ReLife Line





With certified recycled plastics, it contributes to the recovery of materials and the reduction of environmental impact.



Accessories

	<p>Knurled Pin</p> <ul style="list-style-type: none"> • Ø 8 x 10 - Stem 7 x 27 • Ø 8 x 12 - Stem 7 x 27 • Ø 8 x 13 - Stem 7 x 27 • Ø 8 x 16 - Stem 7 x 27 • Ø 8 x 20 - Stem 7 x 27 • Ø 8 x 28 - Stem 7 x 27 		<p>Grip Neck Pin</p> <ul style="list-style-type: none"> • Ø 6 x 20,6 gola - Stem 7 x 27 • Ø 7 x 32 - Stem 7 x 27 • Ø 8 x 17 - Stem 7 x 27
	<p>Circlip Pin</p> <ul style="list-style-type: none"> • Ø 8 x 20 - Stem 7 x 27 • Ø 8 x 30 - Stem 7 x 27 • Ø 11 x 20 - Stem 7 x 27 		<p>Threaded Pin</p> <ul style="list-style-type: none"> • Ø M6 x 12 - Stem 7 x 27 • Ø M6 x 15 - Stem 7 x 27 • Ø M8 x 15 - Stem 7 x 27 • Ø M8 x 32 - Stem 7 x 27 • Ø M10 x 15 - Stem 7 x 27 • Ø M8 x 10 washer 18 - Stem 7 x 27 • Ø M8 x 12 washer 18 - Stem 7 x 27
	<p>Plates</p> <ul style="list-style-type: none"> • 28x28 - Interaxle 20 x 20 - Stem 7 x 27 • 38x38 - Interaxle 28 x 28 - Stem 7 x 27 • 42x42 - Interaxle 32 x 32 - Stem 7 x 27 		

Tube Inserts

	<p>Grip Neck Tube Inserts</p> <ul style="list-style-type: none"> • Round Diam. 8 mm x 26 mm length - compatibility PN. 7x27 - 6x20,8 • Round Diam. 9 mm x 27 mm length - compatibility PN. 7x27 - 7x32 • Round Diam. 10 mm x 27 mm length - compatibility PN. 7x27 - 7x32 • Round Diam. 10 mm x 23 mm length - compatibility PN. 7x27 - 6x20,8 • Round Diam. 12 mm x 22 mm length - compatibility PN. 7x27 - 8x17 • Round Diam. 13 mm x 19 mm length - compatibility PN. 7x27 - 8x17 • Round Diam. 14 mm x 23 mm length - compatibility PN. 7x27 - 8x17 • Round Diam. 18 mm x 27 mm length - compatibility PN. 7x27 - 7x32 • Round Diam. 20 mm x 30 mm length - compatibility PN. 7x27 - 7x32 • Round Diam. 23 mm x 29 mm length - compatibility PN. 7x27 - 7x32 • Round Diam. 28 mm x 43 mm length - compatibility PN. 7x27 - 7x32
	<p>Rivet Tube Inserts</p> <ul style="list-style-type: none"> • Round Diam. 8 mm x 27 mm length / cod. 2-0155 • Round Diam. 8 mm x 22 mm length / cod. 2-0157 • Round Diam. 10 mm x 25 mm length / cod. 2-0136 • Round Diam. 12 mm x 25 mm length / cod. 2-0140 • Round Diam. 12 mm x 28 mm length / cod. 2-0142 • Round Diam. 13 mm x 28 mm length / cod. 2-0141 • Round Diam. 15 mm x 29 mm length / cod. 2-0144 • Round Diam. 16 mm x 29 mm length / cod. 2-0145 • Round Diam. 18 mm x 28 mm length / cod. 2-0146 • Round Diam. 20 mm x 28 mm length / cod. 2-0148 • Round Diam. 23 mm x 28 mm length / cod. 2-0150

